



2+



6



1,65m



1 = 6,3m 2 = 1,2m 3 = 2,6m

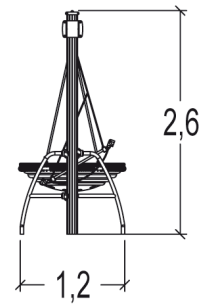
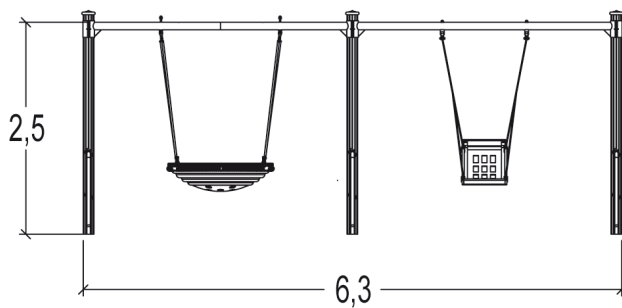

## Spielwert

Schaukeln



## Zugang



Motorische Behinderung

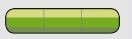

Sensorische Behinderung

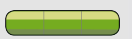

Geistige Behinderung



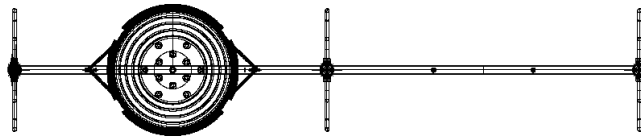



## Montagehinweise





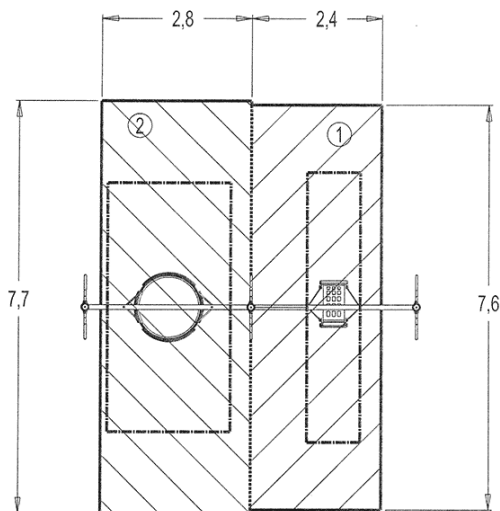

Fallraum: Gemäß der EN 1176-1 mindestens vorzusehender Fallschutzbereich.

———— Fallraum  
 - - - - - Freiraum

 Fallraum bei  
 losen Bodenmaterial  
 (DIN EN 1176 Bb11:2009-1)  
 - - - - - Freiraum

		
1	1,65m	19m <sup>2</sup>
2	2,1m	22m <sup>2</sup>



					
2	03h00	1m <sup>3</sup>	33.5m <sup>2</sup>	245kg	33kg

